

# Axio Imager

## The Future has Arrived



**New level in performance for high-end routine and research: a new era for light microscopy.**



We make it visible.

# Fluorescence

## Carl Zeiss: FluoresScience

**Fluorescence: the basis of many modern methods in the life sciences.**

**Fluorescent proteins in particular have become one of the key techniques in the search for the secrets of life. New and increasingly differentiated fluorescence applications such as FRET, FRAP or FISH are continually being developed so that molecular relationships inside cells can be monitored.**

**For example in complex multicolor FISH experiments for gene detection up to 24 colors are evaluated in parallel.**

Microscope systems for such applications must make even the weakest signals visible and resolve overlapping spectra. They need to document dynamic processes with the highest possible acquisition speed. With imaging software complex applications are made accessible to a wide group of users and enable documentation in all dimensions. Easy to operate and intelligent. These demands will continue to grow.

Developing microscopes and imaging systems that fulfill all these needs is a science in itself. At Carl Zeiss we have committed ourselves to this challenge with uncompromising dedication and

extensive know-how. After all, when you are working at the boundary to the invisible, you can't afford to make any compromises. To give your best, you need the best tools possible:

- **With the highest efficiency.**
- **With the most innovative technologies.**
- **With the most powerful imaging systems.**

From the very beginning Carl Zeiss has set the standards in these areas, in light microscopy and in confocal laser scanning microscopy – with internationally leading technologies for fluorescence. Our focus on key techniques for the research of life has now been given a name – Carl Zeiss: FluoresScience.

A sign for quality and the promise that the best fluorescence tools for the life sciences will continue to be made by Carl Zeiss.

### Primary neurons (rat) in culture

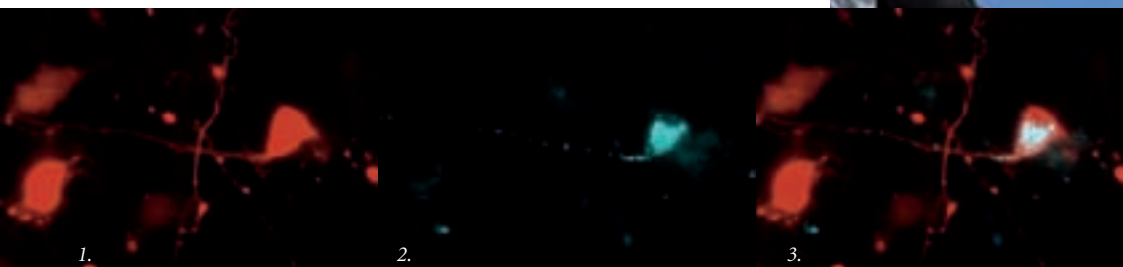

1. Red: YFP-labeled cell bodies.

2. Cyan: CFP-labeled peroxisomes.

3. Multichannel image – overlay of red and cyan channel.



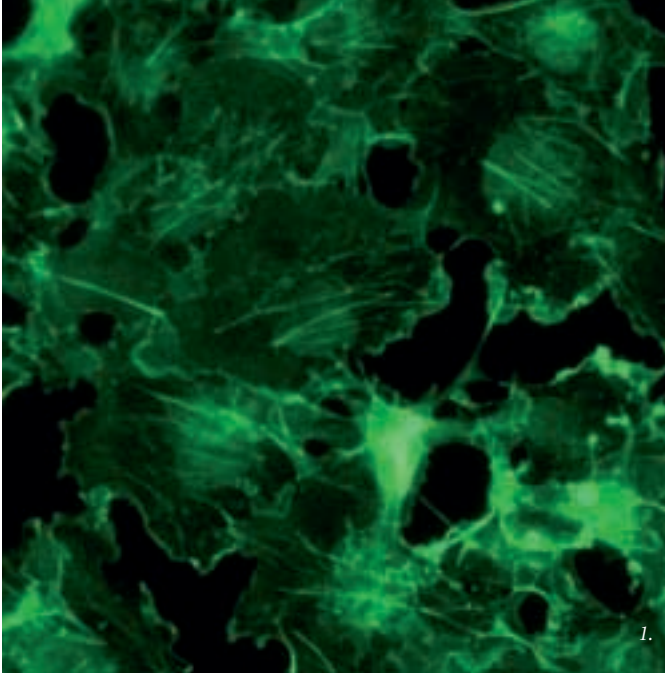

1.

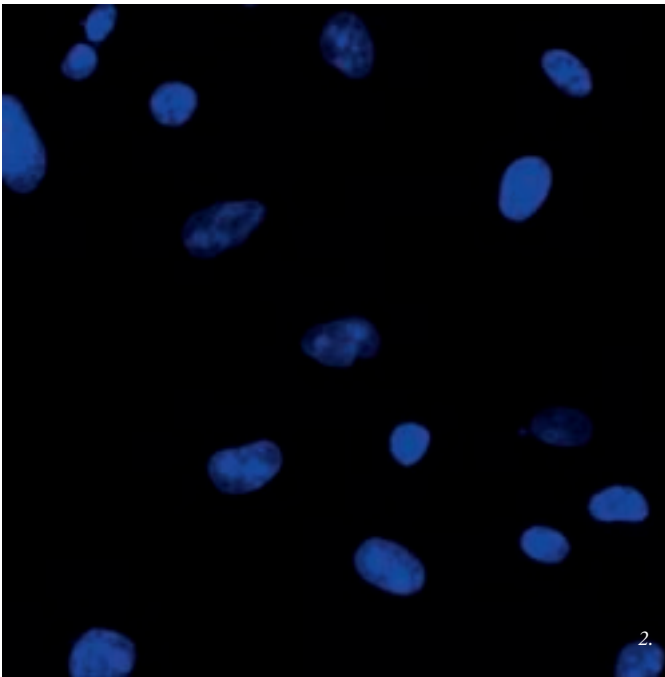

2.

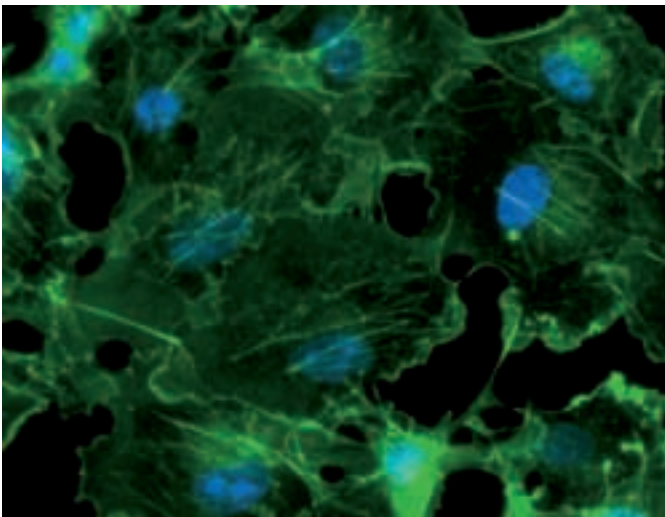

3.

# Contents

<b>Axio Imager</b>	<b>3</b>
<b>Optics</b>	<b>4</b>
<b>Fluorescence</b>	<b>6</b>
<b>Imaging Systems</b>	<b>8</b>
<b>3D Imaging Systems</b>	<b>10</b>
<b>Stand Versions</b>	<b>12</b>
<b>Ergonomics</b>	<b>14</b>
<b>Applications</b>	<b>15</b>
<b>Communication</b>	<b>16</b>
<b>Systems Overviews</b>	<b>18-23</b>

*COS-cell culture.*

*1. Green: Alexa 488 phalloidin-actin.*

*2. Blue: HOE 33342.*

*3. Multichannel image – overlay of green and blue channel.*

*Objective: EC Plan-Neofluar 40x/0.75.*

*S. Haxelmans, R. Nitschke, Inst. Biologie I. Univ. Freiburg, Germany.*





# Axio Imager



1. Brain section (rat) – Multichannel image with ApoTome.

Green: Astrocytes labeled with GFP. Blue: cell nuclei (DAPI).

Objective: Plan-Apochromat 20x/0.6. E. Fuchs, S. Bauch, DPZ Göttingen, Germany.



## **Axio Imager - Enter a New Era**

It is more than just a microscope and more than just an imaging system – Axio Imager signals the dawn of a new era in digital microscopy. Users will discover new standards in terms of performance, fully integrated intelligence and a forward-looking operating concept. As well as more freedom than ever before when it comes to expandability and versatility. The result is an innovative, modular microscopy platform for all your routine and research requirements and applications.

**Axio Imager offers:**

- the ideal imaging solution with uncompromising focus on digital microscopy
- the best optics – IC<sup>2</sup>S Principle with the highest resolution, clearly offering you more information in all contrast methods
- the best fluorescence with higher contrast
- an innovative stand architecture that can be adapted modularly to meet your individual requirements
- an intelligent stand with integrated software for controlling all of your work steps
- highest precision with the imaging cell and a closed loop z-focus
- extremely comfortable ergonomics and operation for more relaxed working, even over long periods.

With Axio Imager, Carl Zeiss is once again setting new standards in light microscopy. Our aim is to provide you with an efficient and economical solution that enables you to meet the increasing challenges you face in the life sciences. To offer you a future oriented platform as a basis for your success.

2. *Drosophila* (3rd instar larva). Red: Fibrillarin. Green: Venus – CG 8571-transgene. Blue: cell nuclei (DAPI). Objective(2. and 3.): EC Plan-Neofluar 40x/0.75. M. Buszcak, A. Spralding, CIW – Dept. Embryology, MD, USA.

3. CHO-cell culture.

Green: GFP-Histon. Red: dsRed.

S. Haxelmans, R. Nitschke, Inst. Biologie I. Univ. Freiburg, Germany.

## Leader in Optics - Clearly Higher Contrast

Axio Imager is redefining the boundaries of optical performance. Our aim is to make even more details visible and to enable you to obtain even more information. All the relevant components have been optimized with this in mind: from the illumination through to the beam path, and from the objectives through to the camera and software interfaces. This has resulted in an unprecedented level of optical quality that will prove indispensable in the future, especially when you are working with fluorescence, DIC or in Darkfield. In comparison to its predecessor the market leader Axioplan 2 imaging from Carl Zeiss the contrast in fluorescence is visibly higher. Very important for weak signals.

### **The IC<sup>2</sup>S beam path - innovation for higher quality**

The beam path, redesigned for Axio Imager, is the result of the systematic optimization of the proven Carl Zeiss ICS infinity optics. Its outstanding benefits include high image contrast, perfect homogeneity and unprecedented resolution. In conclusion, the optical system with its integrated light traps, is such an impressive performer that it deserves a new name:

IC<sup>2</sup>S – Infinity Contrast & Color Corrected System.

### **Free access to the beam path - more flexibility**

With its freely accessible infinity space, Axio Imager allows you to interface additional components, such as light sources and detectors. This means it is extremely easy to build your own individual system solutions, enabling you to realize all your research ideas.

### **High-performance objectives - seeing even more details**

Carl Zeiss has redesigned and systematically expanded its ranges of proven high-performance objectives especially for Axio Imager.

- The EC Plan-Neofluar universal objectives. The consequently minimized stray-light results in a clear increase in contrast, a decisive factor in all microscopic techniques.
- The Plan-Apochromat 63x/1.4 Oil objective is impressive not only due to its outstanding point spread function, but also, in particular, due to its improved chromatic correction.
- The LCI Plan-Neofluar 25x/0.8 and 63x/1.3 Imm Korr objectives have been devised specifically for live cell imaging techniques and calculated for certain temperature intervals.

### **Nosepiece with DIC objectives**



### **LED - the new form of illumination**





### Beam path optics

- a. Ocular
- b. Accessible interface to the  $\infty$  space
- c. Reflector
- d. Objective
- e. Condensor
- f. HBO
- g. HAL

### Flexible interfaces

- 1. Accessible interface to the  $\infty$  FL space
- 2. Reflected light-field diaphragm
- 3. Reflected light-aperture diaphragm
- 4. Transmitted light-field diaphragm
- 5. Filter wheels

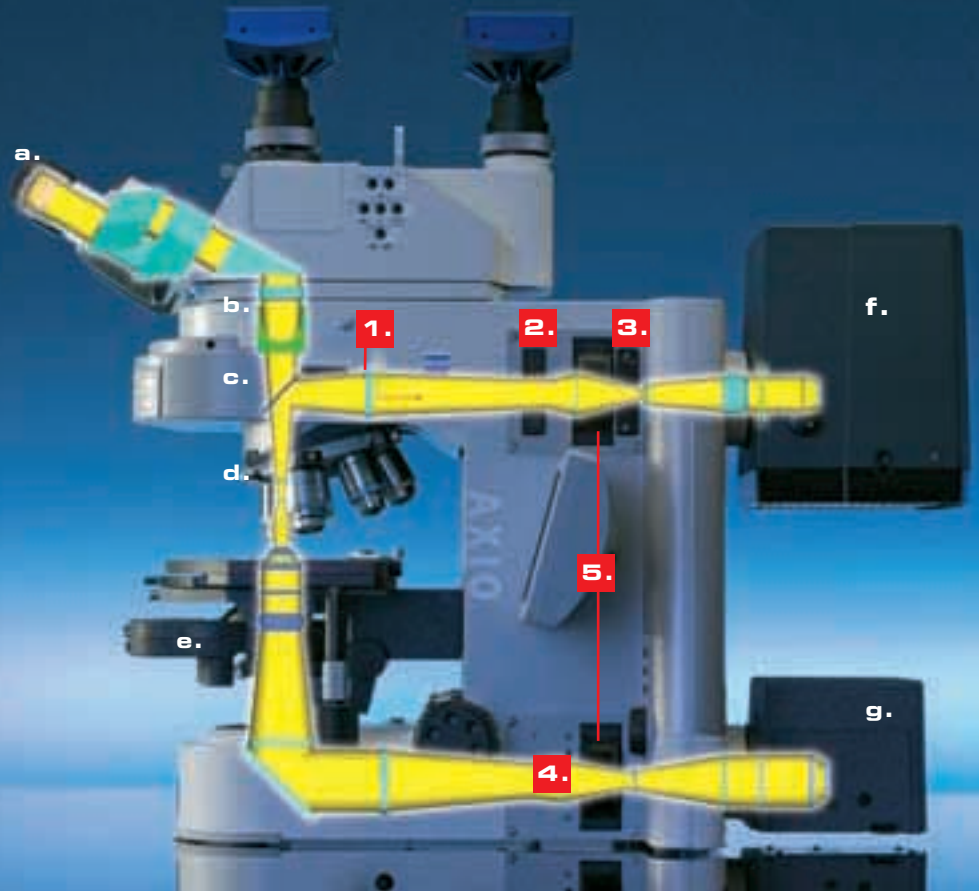

### Perfect DIC - more homogeneous illumination

The even interference contrast with all magnifications from 5x to 100x over the whole field of view. Especially in digital imaging, a time-consuming shading correction is unnecessary. Another decisive advantage is that you can choose between two DIC sliders for the Plan-Apochromat 63x/1.4 and 100x/1.4 objectives: HR for highest resolution or HC for highest contrast – both optimally adapted to your application.

### LED illumination - constant color temperature

The best alternative to conventional halogen illumination. It offers a number of decisive advantages: constant, brightness-independent color temperature, low heat radiation and high durability. The LED illumination system also includes a filter mount to allow individual adjustment of the color temperature to meet your specific requirements. It is fitted directly under the condenser, in accordance with the "fixed Köhler principle", for simple adjustment with all contrasting techniques. Or the LED illumination can be placed at the position of the traditional halogen lamp for full Köhler illumination.

### Application

### DIC slider

### Bulbus olfactorius (frog)

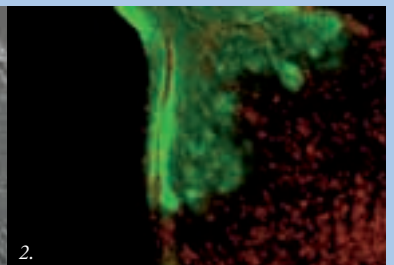

1. *Bulbus olfactorius* (frog) – DIC-image.

2. *Bulbus olfactorius* (frog) – multichannel fluorescence with ApoTome. Green: projections of olfactory receptor cells. Red: cell nuclei. Objective (1. and 2.): EC Plan-Neofluar 20x/0.5. D. Schild, Univ. Göttingen, Germany.

# Superior Fluorescence - More Signal in Less Time

Carl Zeiss has always developed the leading system solutions for fluorescence microscopy, enabling users to obtain new insights at the boundary to the invisible. You set the standards yourself here with your specific microscopy requirements. These are: faster image acquisition, improved color separation, more brilliant signals and even greater ease of operation. Once again Carl Zeiss has developed a forward-looking solution: Axio Imager, a high-performance imaging platform for fast and high-contrast results, especially in the demanding field of fluorescence microscopy.

*Brain section (rat) – two-channel image.  
Green: GFP in astrocytes. Blue: cell nuclei (DAPI).  
Objective: Plan-Apochromat 20x/0.6.  
E. Fuchs, S. Bauch, DPZ, Göttingen, Germany.*

## Two-channel image

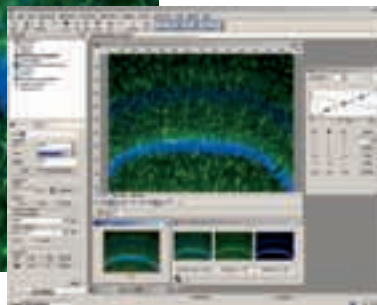
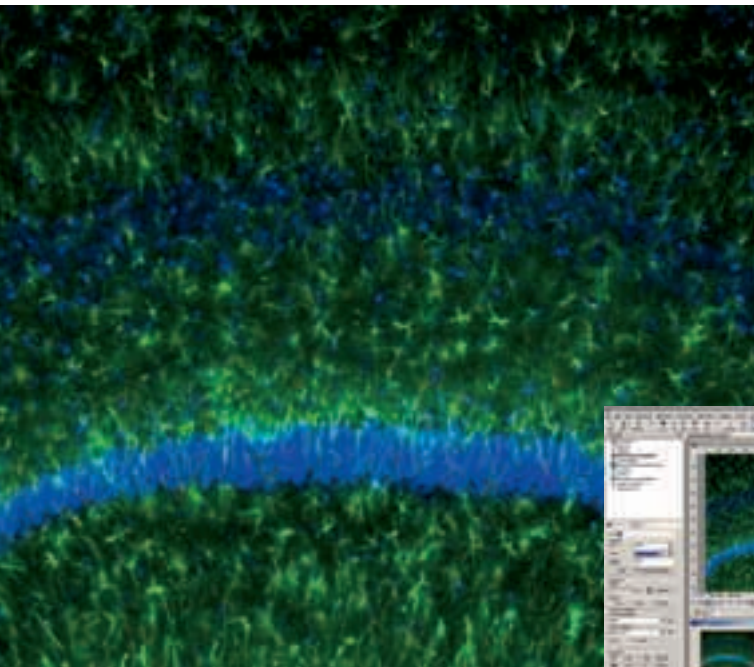

## The reflector turret - faster with 6 or 10 positions

Speed is a key issue with all fluorescence techniques. Carl Zeiss has developed a component that is tailored specifically to this requirement: the fast, motorized reflector turret, which is able to hold six P&C filter modules. For fast multichannel imaging with no loss of time and no unnecessary bleaching. If you want to use more than six dyes at the same time, for example with multi-color FISH applications, the motorized 10x reflector turret with fast position changing guarantees the best results. Perfect, pixel-shift-free signals, even with extremely weak fluorescence.

## The motorized diaphragms - reliable reproducibility

The intelligent, motorized aperture and field diaphragm automatically regulates the contrast and illumination. In the reflected light path and also in the transmitted light path. Objective-specific diaphragm adjustments, for example, can be stored and retrieved at any time. This means reproducibility at the touch of a button.

## Reflector turret



*Fast: the switch from manual to motorized reflector turret.*



# Fluorescence

## High Efficiency filter sets - unsurpassed brilliance

Used for the first time with Axio Imager: the High Efficiency, or HE fluorescence filters, with a clearly improved signal-to-noise ratio. A higher transmission in excitation and emission coupled with steeper cut-off boundaries leads to better separation of signals and optimal efficiency. This results in up to 50% shorter exposure times. To protect your specimen.

## The self aligning HBO lamp - reproducible fluorescence

User-oriented and convenient: the self aligning HBO lamp. The HBO lamp aligns itself automatically every time it is replaced or switched on. This results in a stable optimum setting and a homogeneous illumination of the field of view. Reproducible results for the entire life of the HBO burner.

*HeLa-cells – multichannel image.*

1. Green: GFP.

2. Red: Alpha-tubulin.

3. Blue: cell nuclei (DAPI). Objective: Plan-Apochromat 63x/1.4 Oil.

*L. Pelletier and T. Hyman, MPI für Molekulare Zellbiologie und Genetik, Dresden, Germany.*

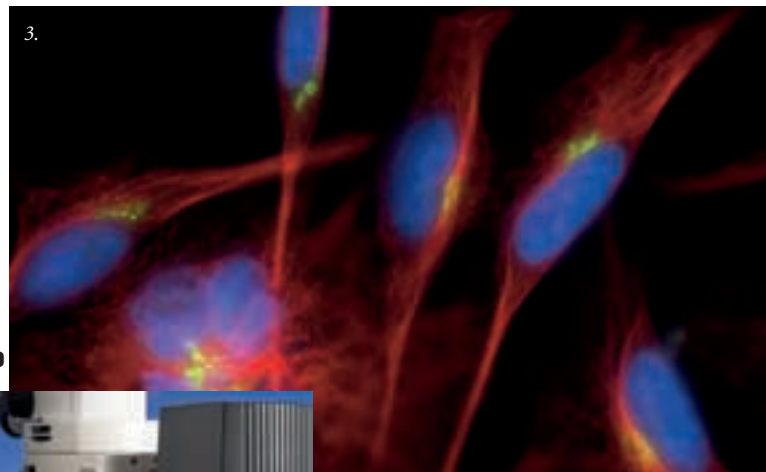
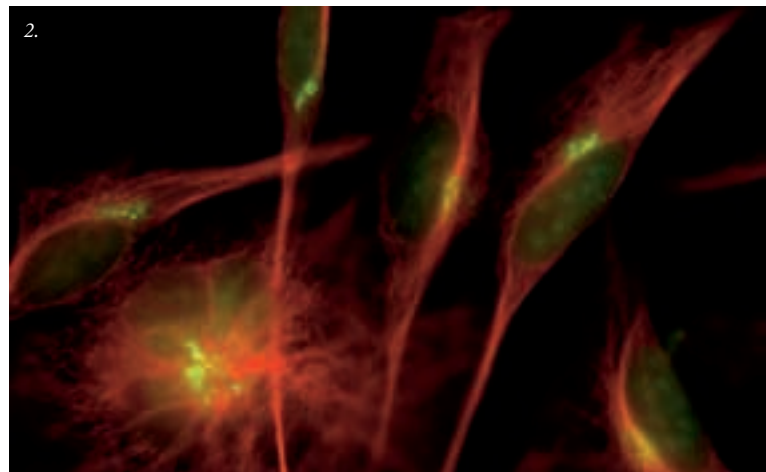
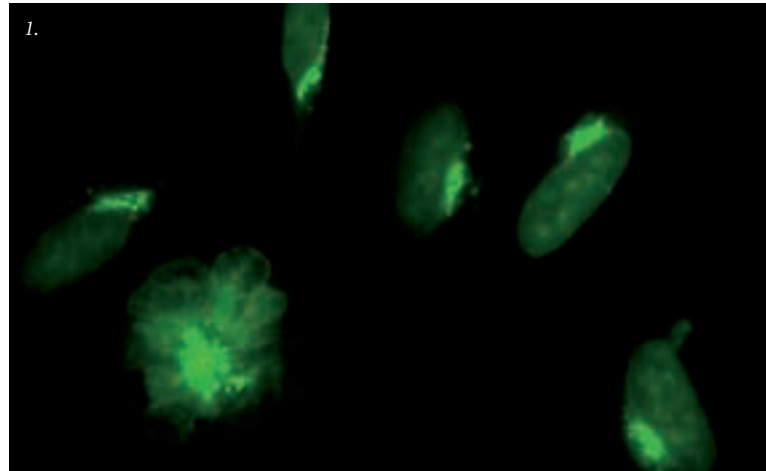

**Filter set**

**TFT display**

**HBO**



*Change to HE filter set.*

*Activating fluorescence on TFT.*

*Self-aligning HBO.*

# Imaging Systems

## Leading Imaging Systems - Performance That Sets Them Apart

Axio Imager is an essential product if you want to perform contemporary digital imaging at the highest possible level. It has been fully integrated into a sophisticated microscopy software the AxioVision, and coordinated with the AxioCam family of digital cameras. Axio Imager offers everything you would expect from a forward-looking imaging platform. It is perfect for both routine and highly specific applications. This is guaranteed by the Carl Zeiss quality promise and by selected partner companies, who set the same high performance standards for their own solutions as they expect from those of Carl Zeiss.

*Easy high-quality digital documentation.*

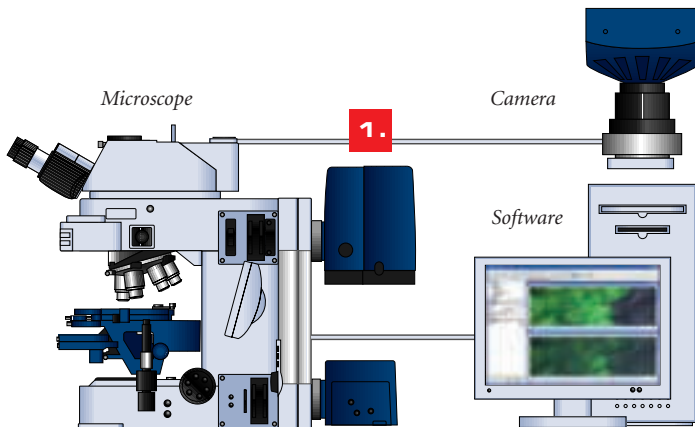

*See table on page 10.*

1. Histological section – brightfield. Red: Anti-CD. Blue: nuclear counterstaining.

Objective (1. and 2.): Plan-Apochromat 63x/1.4 Oil.

### AxioVision – digital intelligence

AxioVision is the high-performance software for user-oriented digital imaging solutions. From image acquisition and processing to image analysis and archiving. AxioVision is practice-oriented, intuitive in terms of operation and easily adapted to your individual requirements. Its modular structure allows you to expand the Carl Zeiss imaging software with versatility. For z-stack, multichannel fluorescence or time lapse images, for example. AxioVision is the solution to meet constantly increasing demands.

### The AxioCam family – flexible specialists for all situations

Carl Zeiss offers a wide range of digital cameras in various performance classes. The monochrome cameras – in the case of separate acquisition of the color channels – impress with their optimum resolution and extremely high sensitivity, especially with weak fluorescent specimens, in 12- or 14-bit dynamics. The color cameras offer excellent color reproduction and superb resolution with up to 12 megapixels per color channel. All cameras are Peltier-cooled and offer the option of fast shutter synchronization. All AxioCam cameras are characterized by a fast live image and full integration into Carl Zeiss systems.

### Histological section

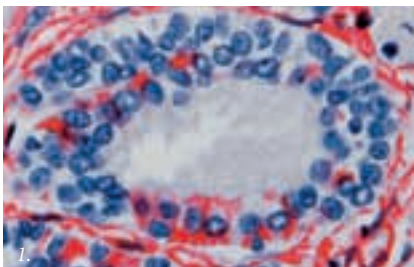

### Primary cell culture

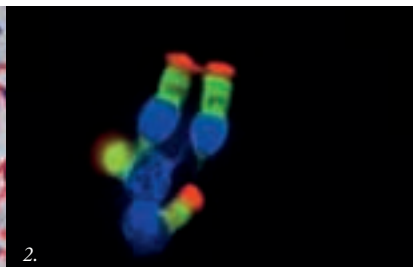

### Fluorescence

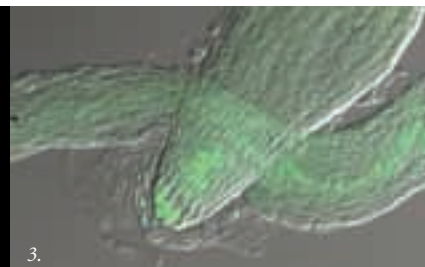

2. respiratory epithelial cells (human) – multichannel image.

Red: Cilia (Alexa –Fluor 546). Green: ER (Alexa Fluor 488). Blue: cell nuclei (Hoechst 33342).

M. Fliegau, H. Olbrich, H. Omran, Zentrum Kinderheilkunde, Uniklinik Freiburg, Germany.

3. Arabidopsis – hair root – DIC image overlaid with fluorescence image. Green: GFP.

Objective: EC Plan-Neofluar 40/0.75.

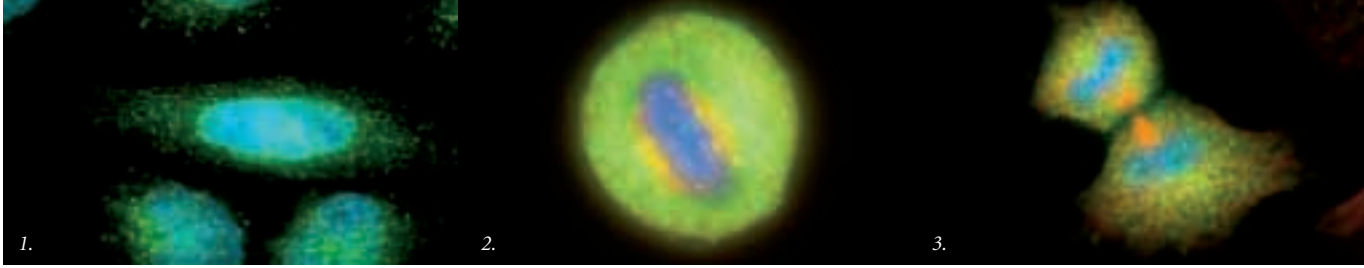

1. Interphase

2. Metaphase

3. Telophase

HeLa-cells – stages of mitosis. Red: Alexa Fluor 594–DM1-alpha. Green: Alexa Fluor 488 Mad2. Blue: DNA (DAPI).

Objective: EC Plan-Neofluar 100x/1.3 Oil. H.Y. Li, Y. Xheng, HHMI & CIW. Dept. Embryology, MD, USA.

### The precise scanning stages - exact positioning

These allow precise control of positions ensuring high reproducibility. Highly sensitive piezo or stepper motors enable you to precisely set and relocate any desired position:

- Piezo scanning stage: stepsize 0.2  $\mu\text{m}$ , reproducibility:  $\pm 0.6 \mu\text{m}$
- Scanning stage with stepper motor: stepsize 0.1  $\mu\text{m}$ , reproducibility:  $\pm 0.3 \mu\text{m}$

These high performance scanning stages are essential components for all automated imaging techniques, such as MosaiX or Mark&Find.

### Cytogenetics - new perspectives in genetic diagnostics

Axio Imager can be used as a forward-looking platform for the fully automatic analysis of even the most complex processes: this is possible in combination with motorized scanning systems and highly specialized software modules, such as Metafer MetaCyte from MetaSystems. With their flexible special solutions, the experts from MetaSystems are opening up undreamed-of possibilities.

*First-class imaging platform: Designed for state of the art digital documentation, Axio Imager is seamlessly integrated into the Carl Zeiss systems environment with the microscope software Axio Vision and cameras of the AxioCam family.*

### High-end biomed system equipment

**MosaiX**

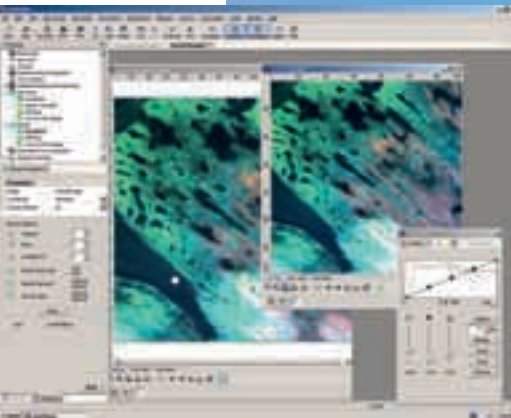

High-resolution overview image of bone thin section with AxioVision MosaiX Modul.

Objective: Plan-Neofluar 10x/0.3.







## Excellence in 3D Imaging – Strong Signals Maximized

The main focus in modern fluorescence microscopy is the selective and specific imaging of information from all dimensions of a sample. The challenge here is to eliminate stray light from regions outside the selected focus planes. Carl Zeiss offers the user three systems, perfectly tailored to your specific application. Together with precise z-motorization and rapid, sample-protecting image acquisition, these systems are essential for achieving glare-free optical sections, optimum contrast and excellent visualization in 3D.

### 3D mathematically – AxioVision 3D Deconvolution

The powerful AxioVision 3D Deconvolution software from Carl Zeiss mathematically calculates the stray light from outside the focus plane back to its point of origin. The object acquired in the 3D

image stack is therefore arithmetically “unfolded”. The result is first-class image quality, especially in samples with very weak fluorescence for which the light efficiency is essential.

### 3D award winner – ApoTome

The ApoTome is the solution if you are looking for sensational image quality with an instant display for tissue and thicker samples. It is simply installed in the plane of the field diaphragm of the reflected light beam path of the Axio Imager.D1 and Z1. The principle of fringe projection is used to create precise optical sections online. With increased contrast and greatly improved axial resolution. The ApoTome was recognized in 2003 with the R&D 100 and the Photonics Circle of Excellence Awards.

### Axio Imager – the system – recommended entry-level equipment

		1.	1.	1.	2.	3.	3.	3.	4.
System components			SW	SW	S SW	S SW	S SW	LC A	LS
			C	C M	C M	C	C M	C M	M
Stand versions	A1/A1m	+	+						
	M1/M1m			+	+				
	D1/D1m		+			+			
	Z1/Z1m			+	+		+	+	+
Observation	+								
Documentation		+							
Image analysis		+	+						
Time lapse imaging			+	+					
Multichannel fluorescence		+	+						
3D imaging			+	+					
3D deconvolution			+						
ApoTome						+	+	+	
Live cell imaging					+	+	+	+	
Confocal imaging							+		
FRET				+				+	
Single molecule detection			+						
Telemicroscopy					+				
Elispot					+				
Materials analysis			+		+				

S Scanning stage  
 C Camera  
 A ApoTome  
 LS LSM  
 LC Incubation for live cell Imaging  
 M Motorized microscope  
 SW System software

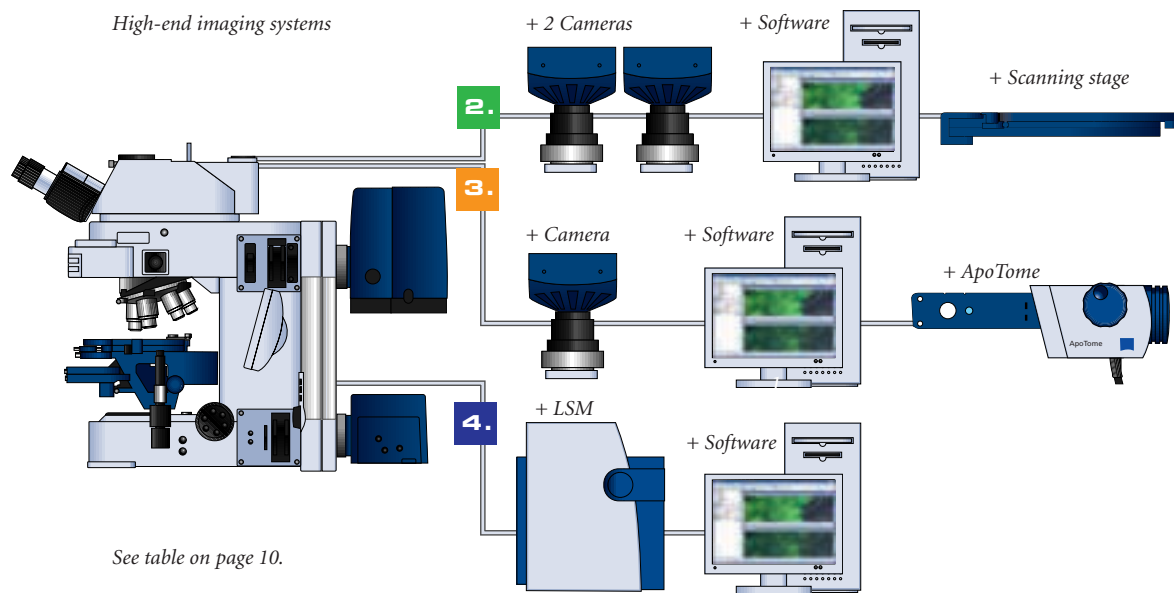

### 3D High-end - the LSM family

Confocal laser scanning microscopy is high-end technology in fluorescence. A unique advantage: With the LSM META system, you can record even spectrally resolved image information. The concept of emission fingerprinting uses the spectral dimension in order to precisely separate fluorescence signals, even when the emission spectra of the stains almost completely overlap. The new LSM LIVE systems enable revolutionary scanning speeds >100 frames/sec. at full resolution and even higher sensitivity for current applications in live cell imaging. The LSM ConfoCor systems make it possible to quantitatively image individual molecular dynamics. The LSM NLO systems offer worldwide leading multiphoton technology. Regardless of which LSM application is used, Axio Imager provides the right platform for a powerful LSM workstation, whether with solo scanning heads or combined ones for effective synergy.

### The motorized focus drive - precision in the z-direction

When it comes to z-motors, Axio Imager offers you two different choices. The standard solution with a stepsize of 25 nm and with a reproducibility of  $\pm 25$  nm. For highest demands, such as in confocal microscopy, or for the creation of z-stacks with extremely small increments, for Axio Imager.Z1 a z-motor with a stepsize of 10 nm and a reproducibility of  $\pm 10$  nm – at three times the speed is available.

### The closed loop system - highest focus precision

If you need to meet extremely high demands, the Axio Imager.Z1 with the focus linear sensor offers you accuracy of  $\pm 1$  nm in the z-direction. On one hand the sensor detects the application-independent movements of the microscope stage and makes corresponding adjustments. On the other hand the system performs extremely precise and reproducible z-stacks with equidistant step sizes, offering you maximum control and certainty.

## LSM

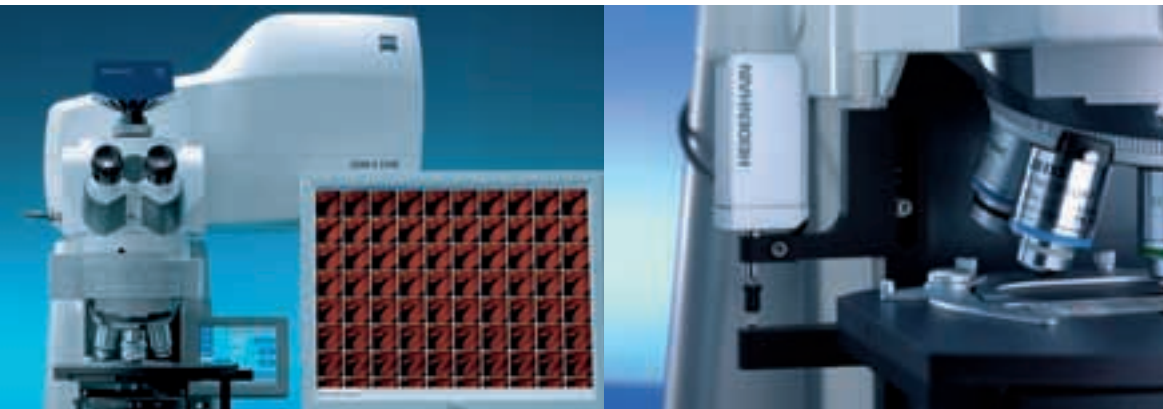

With a precision of  $\pm 1$  nm, the focus linear sensor (closed loop) meets the highest demands.

## Forward-looking Stand Design - Flexibility x 4

Even at first sight, Axio Imager impresses with its stand design. What was important during the design process, however, was to ensure that this innovative architecture created the basis for an unusually high level of flexibility. Axio Imager is a microscope platform for every need and every budget. Preconfigured or freely configurable. Manual or motorized.

### The stands - an economical choice

A high degree of flexibility is offered by the two freely configurable stand variants: Z1 (motorized) and D1(manual). These are ideal for users who want to keep every option open for future applications. For clearly defined applications and budgets, the preconfigured stands M1 (motorized) and A1 (manual) are a particularly appropriate choice. With their generous basic features they are an attractive alternative.

### The Imaging Cell - observe without vibrations

The core elements of Axio Imager, such as the nosepiece, z-guide and stage, have been systematically isolated from the stand as a "stable cell". The entire unit has been designed to be virtually vibration-free and insensitive to thermal influences. Even over longer periods. It therefore creates even better conditions for imaging, especially with long tests and time lapse image acquisition procedures.

#### Axio Imager.A1

*Manual and preconfigured*

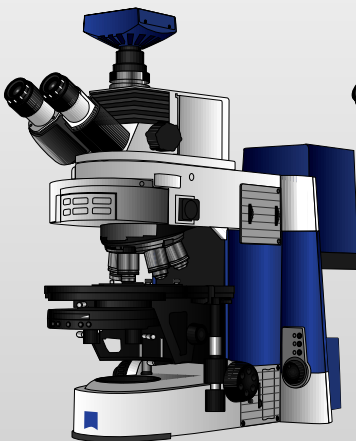

#### Axio Imager.M1

*Motorized and preconfigured*

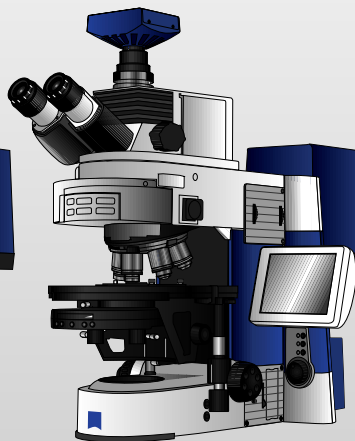

#### Axio Imager.D1

*Manual and freely configurable*

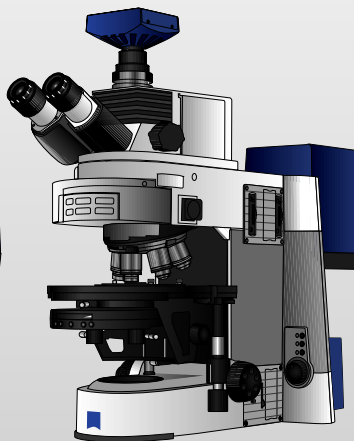

#### Axio Imager.Z1

*Motorized and freely configurable*

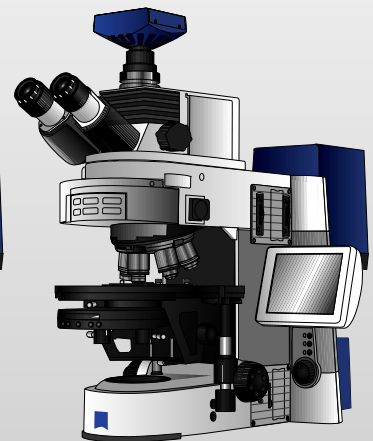



# Stand Versions

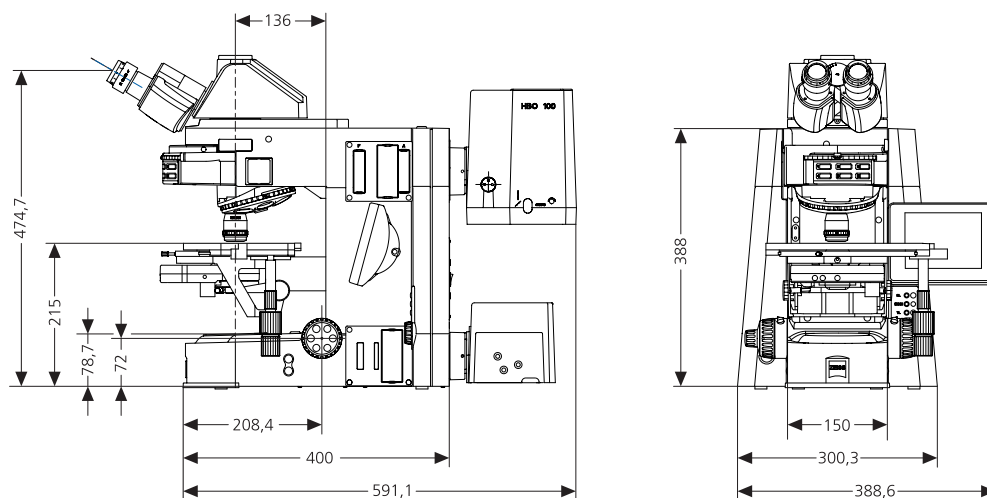

## Axio Imager - flexibility for all areas of application

Component	Option	A1	M1	D1	Z1	A1m	M1m	D1m	Z1m
Stand	manual	+	-	+	-	+	-	+	-
	motorized	-	+	-	+	-	+	-	+
Encoding	readable by PC	-	+	0	+	+ *	+	0	+
Tube lens turret	manual	0	0	0	0	0	0	0	0
	motorized	-	0	0	0	0	0	0	0
Reflector turret	6x manual	0	-	0	0	0	-	0	0
	6x encoded	0	-	0	0	0	-	0	0
	6x motorized	-	+ **	-	0	-	+ **	-	0
	10x motorized	-	-	-	0	-	-	-	0
Nosepiece	6x manual H	0	0	0	0	0	0	0	0
	6x manual HD DIC	0	0	0	0	0	0	0	0
	6x manual POL	0	0	0	0	0	0	0	0
	6x encoded HD DIC	0	0	0	0	0	0	0	0
	6x motorized HD DIC	-	0	-	0	-	0	-	0
	7x encoded HD DIC	0	0	0	0	0	0	0	0
	7x motorized HD DIC	-	0	-	0	-	0	-	0
Stage carrier	fixed	+	+	0	0	-	-	-	-
	changeable	-	-	0	0	+	+	+	+
Transmitted light illumination	manual	+	0	0	0	0	0	0	0
	motorized	-	0	-	0	-	0	-	0
Filter wheels (transmitted light)	manual	+	0	0	0	0	0	0	0
	motorized	-	0	-	0	-	0	-	0
Reflected light*** illumination with built in diaphragms	manual	0	0	-	-	+	+	-	-
	manual	-	-	0	0	-	-	0	-
	motorized	-	-	-	0	-	-	-	0
Diaphragm slider reflected light/Filter wheel	manual	-	-	0	0	-	-	0	0
	motorized	-	-	-	0	-	-	-	0
Focus (z-axis)	manual	+	-	+	0	+	-	+	0
	motorized 25nm	-	+	-	-	-	+	-	-
	motorized 10nm	-	-	-	0	-	-	-	0
Z-focus drive – built-in variant right/left		0	0	0	0	0	0	0	0
TFT display		-	+	-	+	-	+	-	+
Automatic Component Recognition (ACR)		-	-	-	0	-	-	-	0
ApoTome		-	-	0	0	-	-	0	0
Power supply	external	-	+	-	+	-	+	-	+
	internal	+	-	+	-	+	-	+	-

+ = included in stand  
 0 = optionally available  
 - = not available  
 m = MAT-stand  
 \* = partly readable

\*\* = with "included in stand" reflector turret, one of the following options is required:  
 a) Reflected Light DIC-Turret or b) compensator-holder or c) cover (no functionality).  
 \*\*\* = a motorized shutter (standard) is included in every reflected light illumination.  
 At ordering it can be replaced with a high-speed shutter.



## Convincing Ergonomy - Be 100% Relaxed in Your Work

For Axio Imager, Carl Zeiss has created a forward-looking operating concept and has greatly simplified numerous functions. Our aim is to relieve the strain on the user even more, especially when you are working on the system for long periods. You can therefore concentrate fully on your application. All this is supported by technology that can be operated intuitively, irrespective of whether it is manual or motorized.

### The touch screen - key information at a glance

To simplify complex steps, the motorized Axio Imager has all functions grouped together for the first time on a touch screen (TFT) display: this allows you to control all motorized components easily at the touch of a button and display the microscope's status. The integrated light manager constantly ensures the best possible light and contrast setting. In addition to fixed presettings, it is also possible to store complex procedures as settings and retrieve them at any time with just the touch of a button. The perfect way to ensure that Axio Imager runs smoothly in a multi-user environment.

### The control buttons - everything within easy reach

Axio Imager has a well-designed operating concept. The control buttons, which are arranged ergonomically around the focusing drive, can be easily distinguished thanks to their tactile surfaces. The motorized offers 10 buttons whose functions can be freely configured. The manual stand has 5 pre-configured buttons which allow a simple adjustment of light intensity and the switching of the motorized shutters in reflected and transmitted light.

### The control panel - freely positionable\*

Axio Imager can also be remotely controlled using a freely positionable control panel. This panel includes a focusing drive and brightness regulator. You can also pre-program functions of your choice. The panel offers an interface for the TFT and for the x- and y-control of the motorized stage. A well thought-out concept that gives you greater freedom of movement.

### The ergotube - ideal viewing

Used for the first time with Axio Imager: the new 50-15-50 ergotube from Carl Zeiss with upright, unreversed image. With 50 mm height adjustment, a fixed viewing angle of 15° (which is ergonomically ideal) and eyepiece extension of 50 mm, it satisfies the highest standards in terms of comfort. You can therefore work in a relaxed posture when using your microscope, even over long periods.



Ergo phototube

Focus drive



New ergotube for optimal comfort.

Ergonomically positioned operating knobs.

1. *Drosophila* - nervous system - DIC - image. Brown: AEC staining. Objective: EC Plan-Neofluar 20x/0.5.

# Applications



*Histological section – multichannel image with ApoTome.  
Red, green and blue channel overlaid.*

1. Red: dsRed.
2. Green: GFP-actin.
3. Blue: cell nuclei (DAPI).

*Objective: Plan-Apochromat 63x/1.4 Oil.*

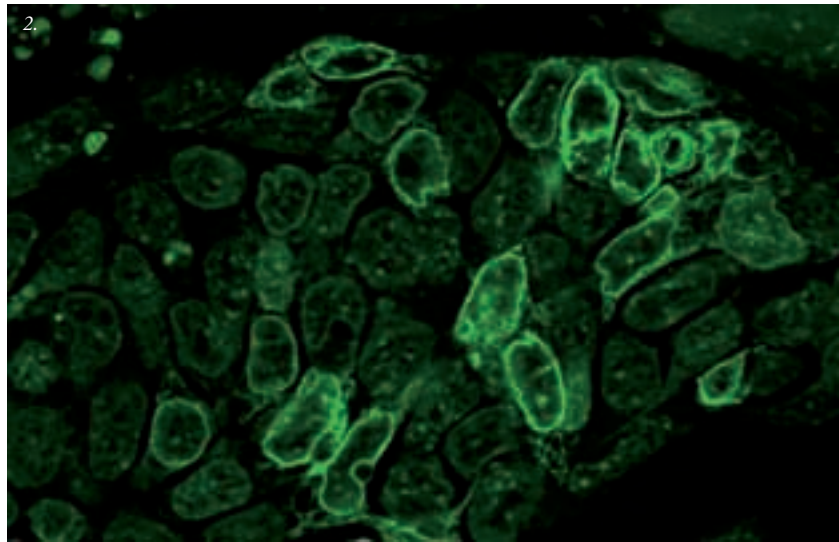
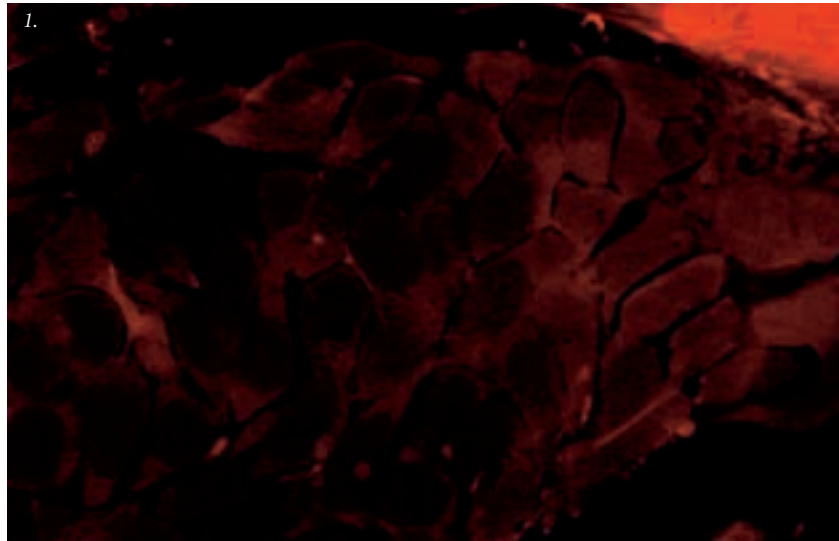

**AxioVision**

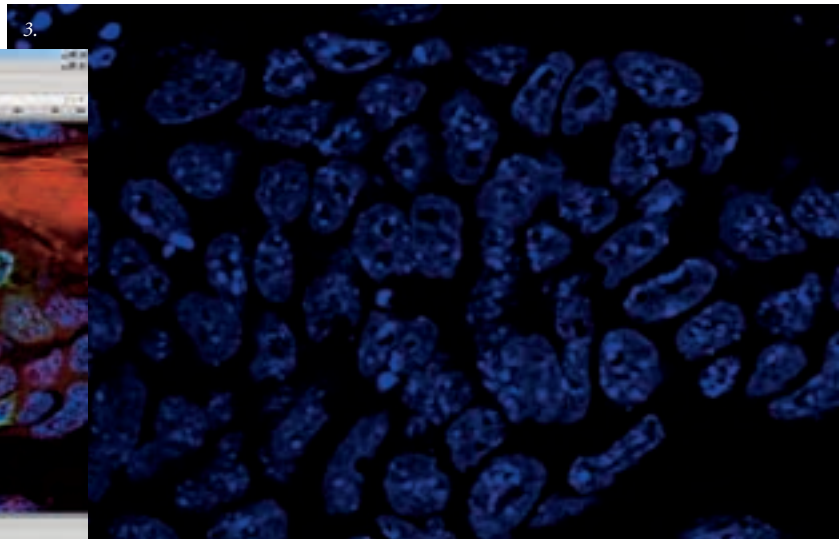
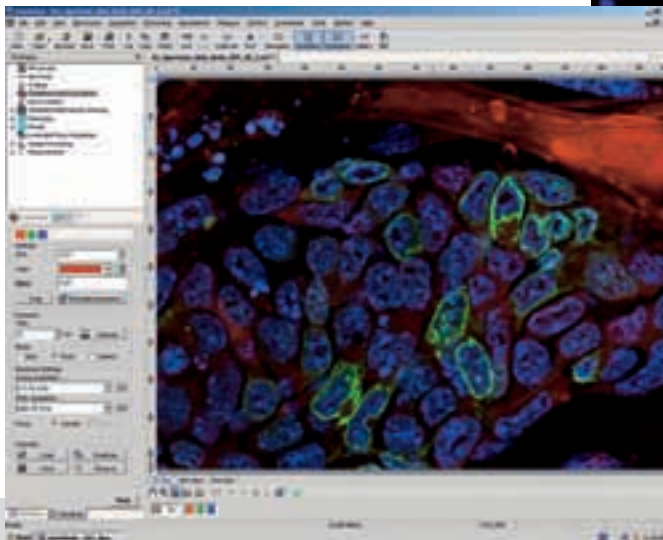



# Communication

## Intelligence Inside the Microscope - Fast Communication

As the wealth of information you are working with grows, so do demands on communication and data management. With Axio Imager, for the first time a microscope fully complies with these requirements. In developing Axio Imager, Carl Zeiss has incorporated intelligence into the stand and integrated up-to-date interfaces. Axio Imager is therefore networkable and remote-controllable. And what's more, intelligent controls now simplify complex procedures.

### ACR - intelligent and convenient\*

ACR stands for the innovative concept of automatic component recognition. This means that Axio Imager.Z1 identifies the objectives and reflector modules that you are using completely independently. If you exchange a component, the new component is immediately recorded in the system. This offers you an important advantage in terms of ease of operation and security: operating errors and complex programming will be eliminated.

\* Available from 07.2005

### Network possibilities of Axio Imager

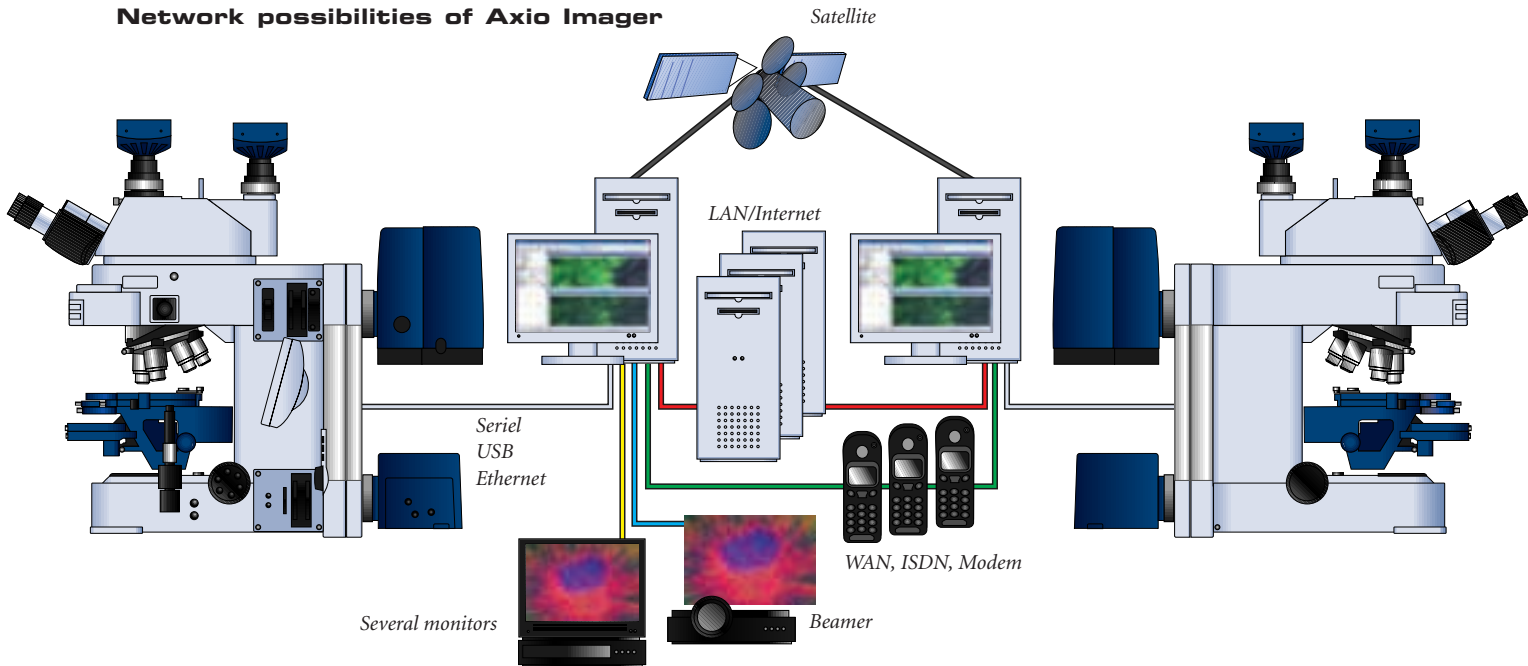

1. Histological section-  
Red: CD61. Blue: nuclear counterstaining.  
Objective: EC Plan-Neofluar 20x/0.5.

2. Histological section-  
Red: MPOX2. Blue: nuclear counterstaining.  
Objective: EC Epiplan-Neofluar 10x/0.3.

A. Schmitt-Gräff. Pathologie,  
Univ. Freiburg, Germany.

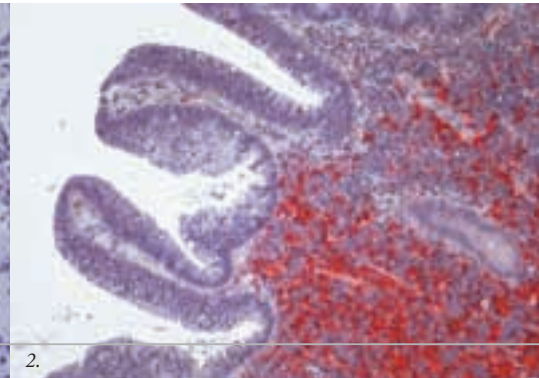
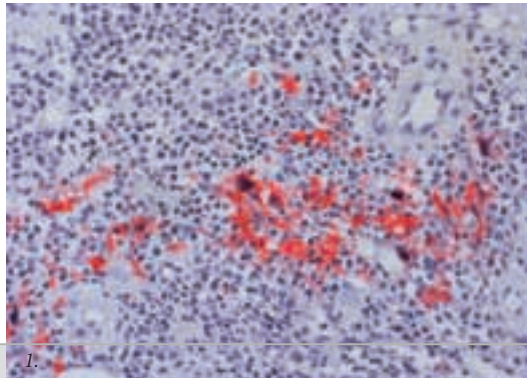

A clear advantage in terms of operating comfort and safety with Axio Imager.Z1: the automatic component recognition ACR identifies objectives and reflector modules independently.



**ACR reflector module**

**ACR objective**

**The TCP/IP protocol - opening up networking**

Axio Imager is equipped with an Ethernet connection, which gives it an Internet and network capability. This means that for the first time it is possible to control the microscope remotely via external workstations, allowing you to extend your operating range. In the future, it will also be possible to obtain online updates or remote services from Carl Zeiss via this interface.

**The USB interface - rapid data flow**

The new USB interface, together with the CAN-BUS system, ensures the rapid exchange of data between the microscope and your computer. A typical 3 channel fluorescence experiment with Axio Imager and AxioVision 4.3 is up to 40% faster than its predecessor.

**Communication mounts**

1. RS232	4. CAN	7. RS232
2. TCP/IP	5. CAN	8. Closed Loop
3. USB	6. CAN	9. Service interface

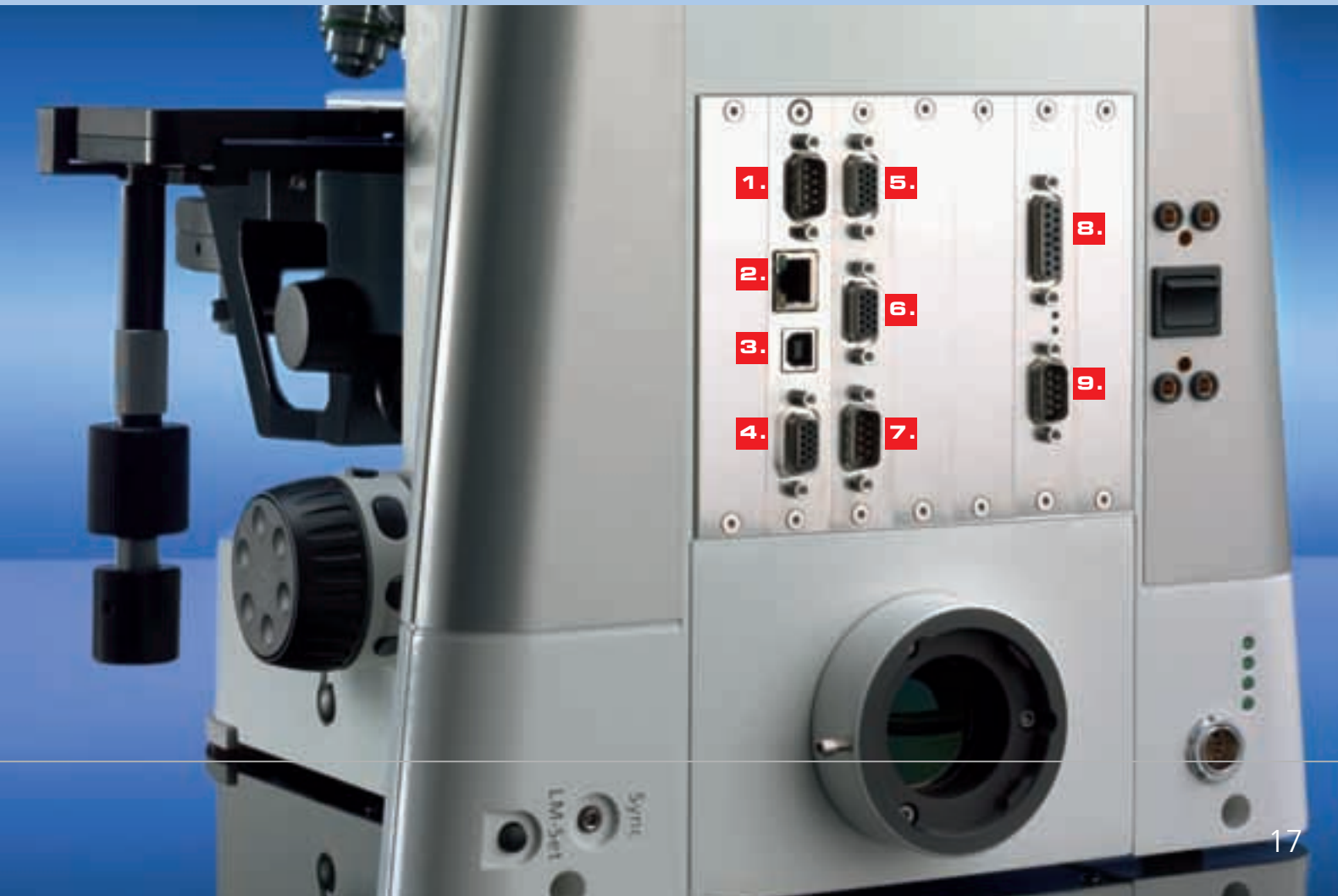

# Axio Imager -

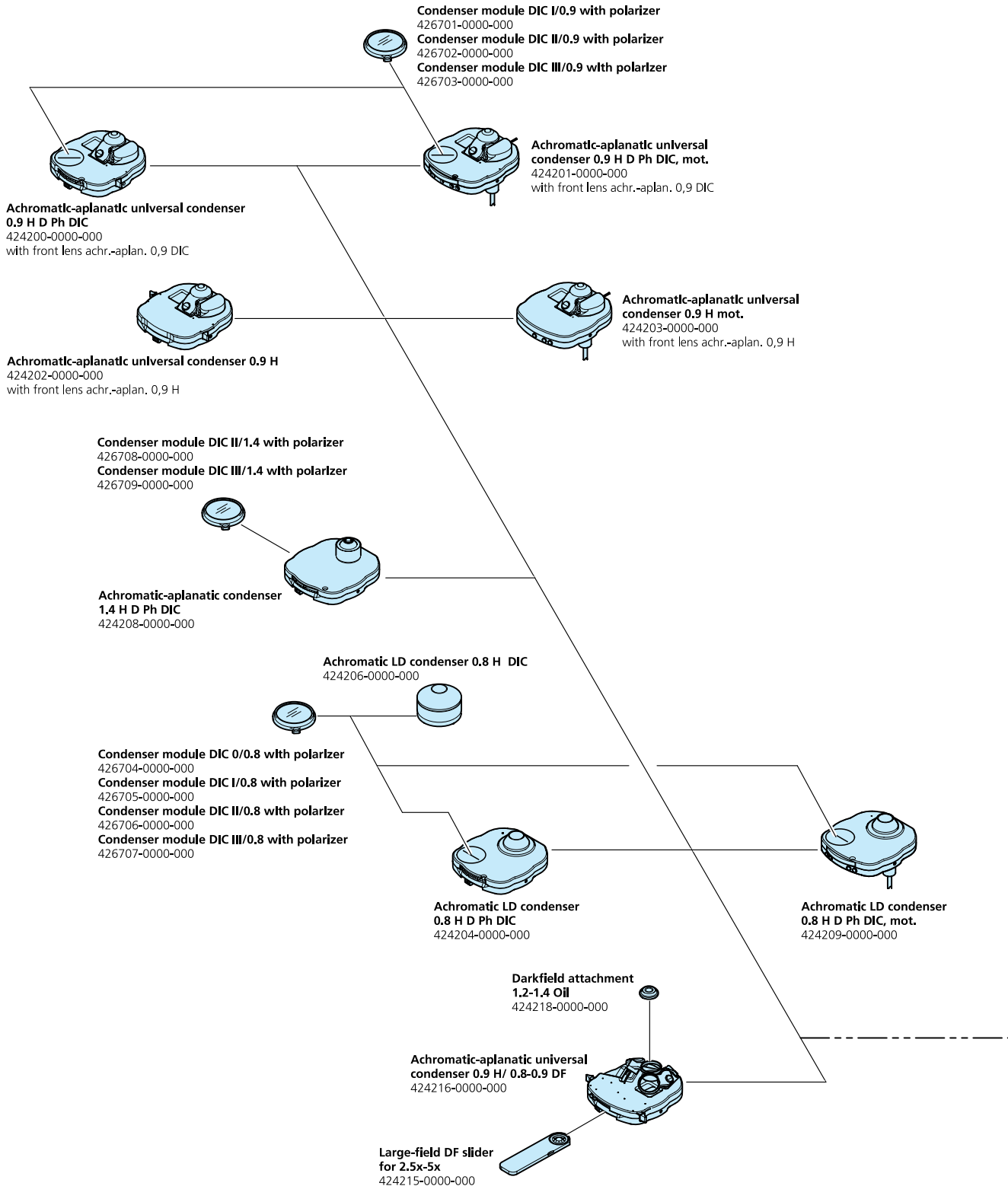



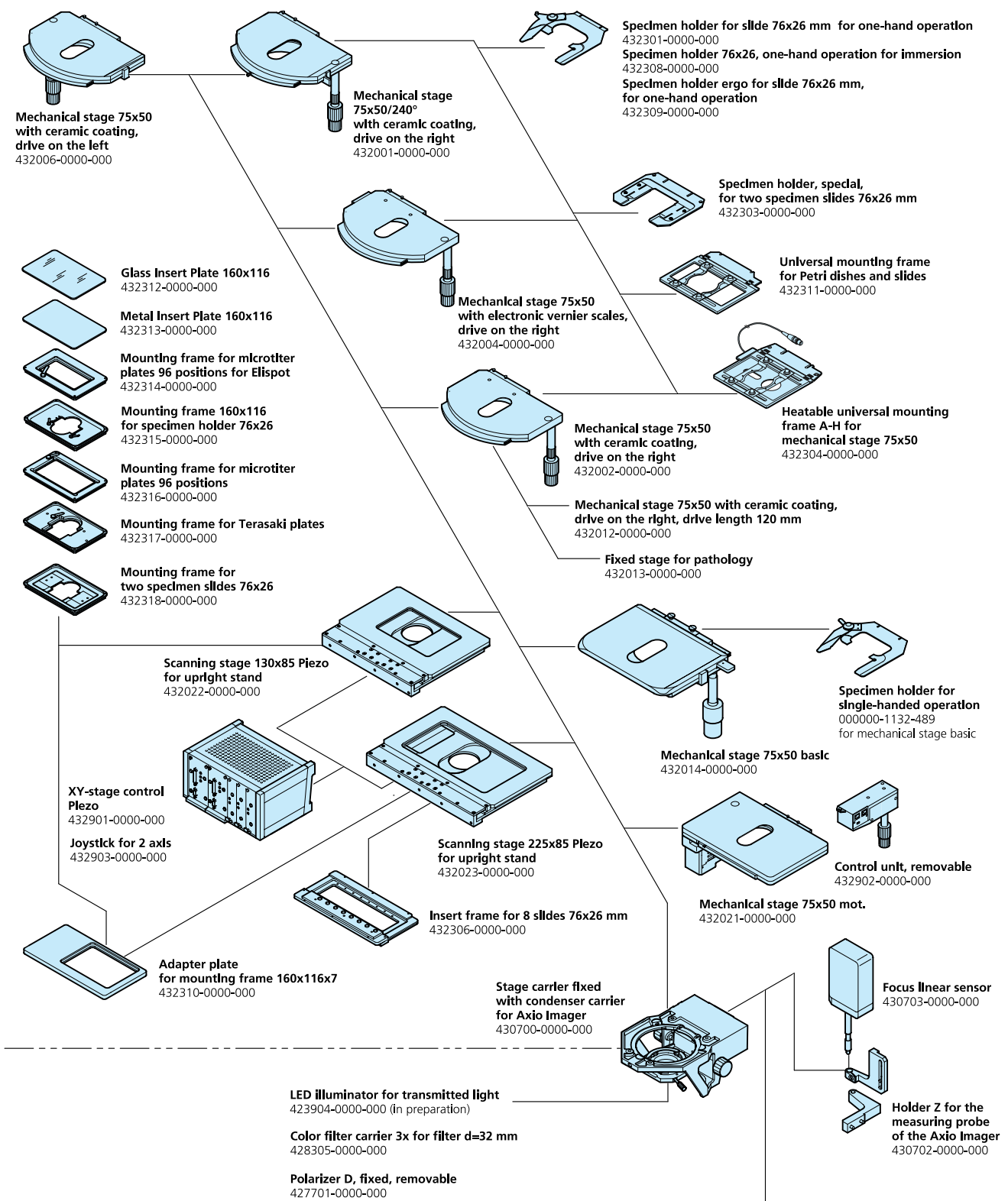

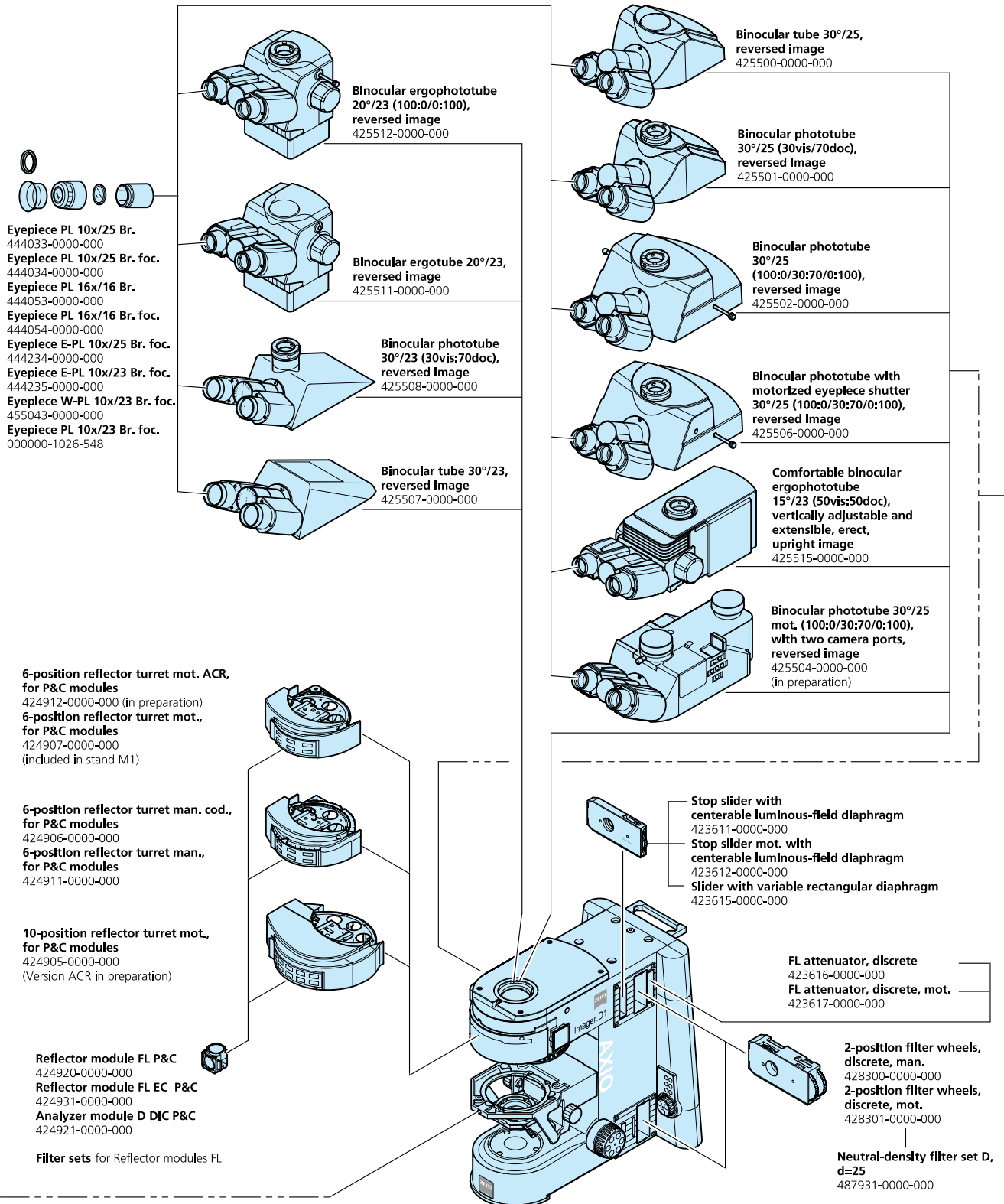

# Axio Imager

**Tube-lens 1.25x**  
425303-0000-000  
**Tube-lens 1.6x**  
425304-0000-000  
**Tube-lens 2.5x**  
425305-0000-000  
**Tube-lens 4.0x**  
425307-0000-000

**5-position tube lens turret, man., with Bertrand system**  
425301-0000-000  
with Tube-lens 1.0x  
**5-position tube lens turret, mot., with Bertrand system**  
425302-0000-000  
with Tube-lens 1.0x

**Co-observation equipment, right, panel, light-intensive**  
425142-0000-000  
**Tube carrier R (connection) for multi-observation equipment**  
452381-9901-000  
**Tube carrier L (connection) for multi-observation equipment**  
452382-9901-000  
**Tube carrier R (panel) for multi-observation equipment**  
452383-9901-000  
**Tube carrier L (panel) for multi-observation equipment**  
452384-9901-000

**Binocular tube 30°/20 for several observers**  
452927-9901-000  
on Tube carrier (R and L)  
with  
**Eyepiece E-PL 10x/20 Br. foc.**  
444232-9902-000

**Center component for multidiscussion equipment with light pointer**  
425141-0000-000

**Note:**

Alternatively to the existing coupling plate without tube lens, the tubes 425500-0000-000, 425501-0000-000, 425502-0000-000, 425506-0000-000, 425515-0000-000, can be combined with a tube lens turret or the center component for multidiscussion equipment.

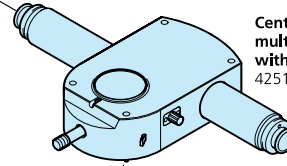
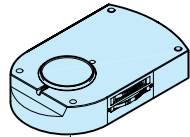

**Compensator mount 6x20**  
424705-0000-000

**Antiglare screen**  
452163-0000-000

**Analyzer slider D, fixed**  
433605-0000-000

**DIC sliders**  
426940-0000-000  
to  
426959-0000-000

**6-position objective nosepiece, HD DIC M27 cod.**  
424504-0000-000  
**6-position objective nosepiece, HD DIC M27 mot.**  
424505-0000-000

**7-position objective nosepiece, HD M27 cod.**  
424501-0000-000  
**7-position objective nosepiece, HD M27 mot.**  
424502-0000-000

**6-position objective nosepiece, HD M27**  
424506-0000-000  
**6-position objective nosepiece, HD DIC M27 mot. ACR**  
424507-0000-000 (in preparation)

**Objective intermediate ring ACR for cylindrical objective sleeve**  
424508-0000-000  
**Objective intermediate ring ACR for conic, short objective sleeve**  
424509-0000-000  
**Objective intermediate ring ACR for conic, long objective sleeve**  
424510-0000-000

**Objectives M 27**  
ICS objectives  
according price list



# Systems Overviews

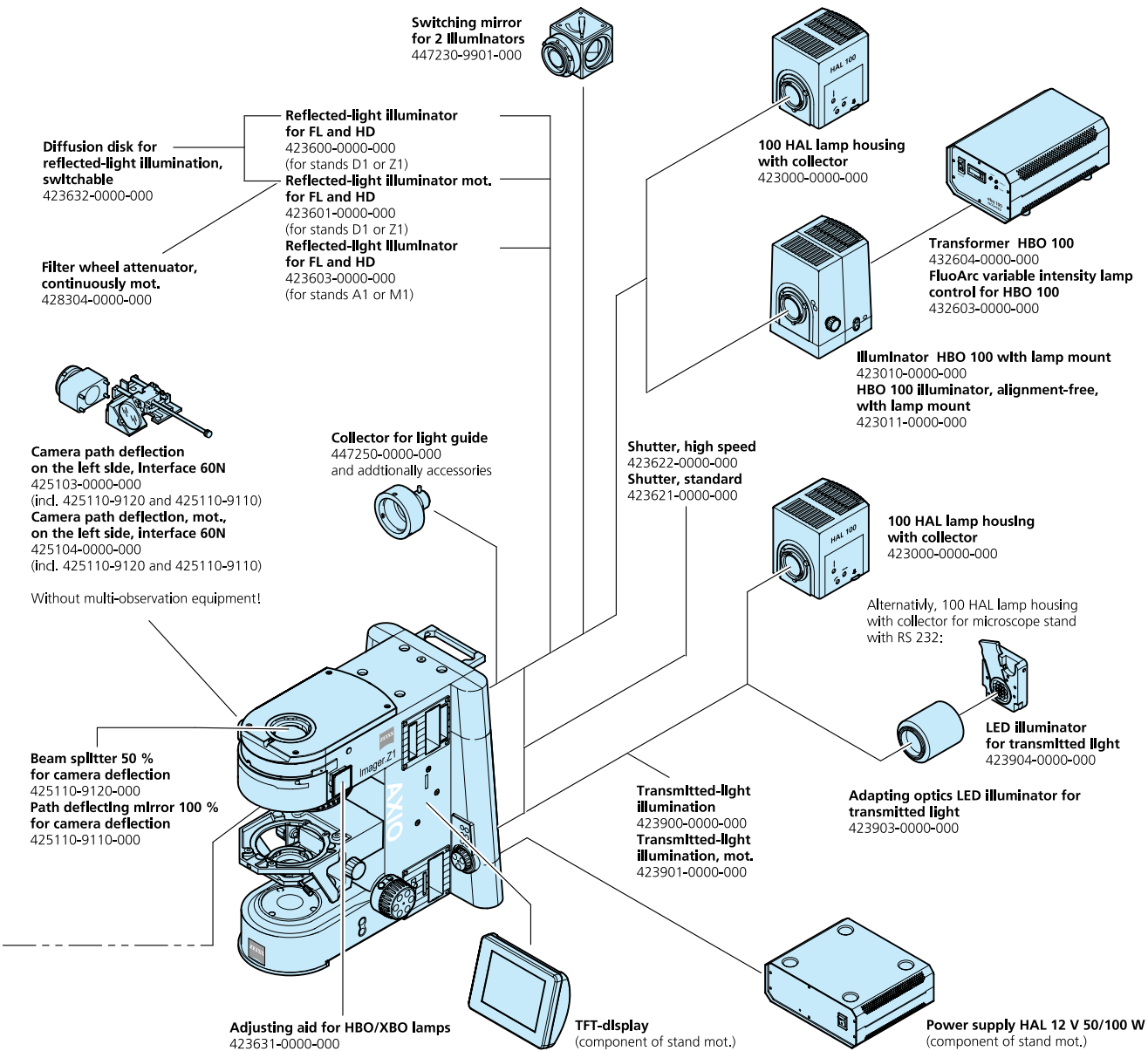

**Axlo Imager.D1 microscope stand**  
430001-0000-000

**Axlo Imager.A1 microscope stand with Light-Control man.**  
430005-0000-000

**Light-Control man.**  
430001-9304-000

**Light-Control mot.**  
430000-9304-000

**Axlo Imager.M1 microscope stand with TFT monitor and Light-Control mot.**  
430004-0000-000

**Axlo Imager.Z1 microscope stand with TFT Monitor and Light-Control mot.**  
430000-0000-000

**Focusing drive man.**  
430001-9110-000

**Focusing drive mot.**  
430000-9110-000

**Note:**

- Always included in A1 and D1 stands:
- **Focusing drive man.** 430001-9110-000
- Always included in M1 stand:
- **Focusing drive mot. basic**
- Options for Z1 stand:
- **Focusing drive man.** 430001-9110-000
- **Focusing drive mot.** 430000-9110-000

Please indicate in your order for all stands the respective number for one of the following options:

- **Option: Z-drive operation on the right** 430051-0000-000
- **Option: Z-drive operation on the left** 430052-0000-000



# Systems Overviews

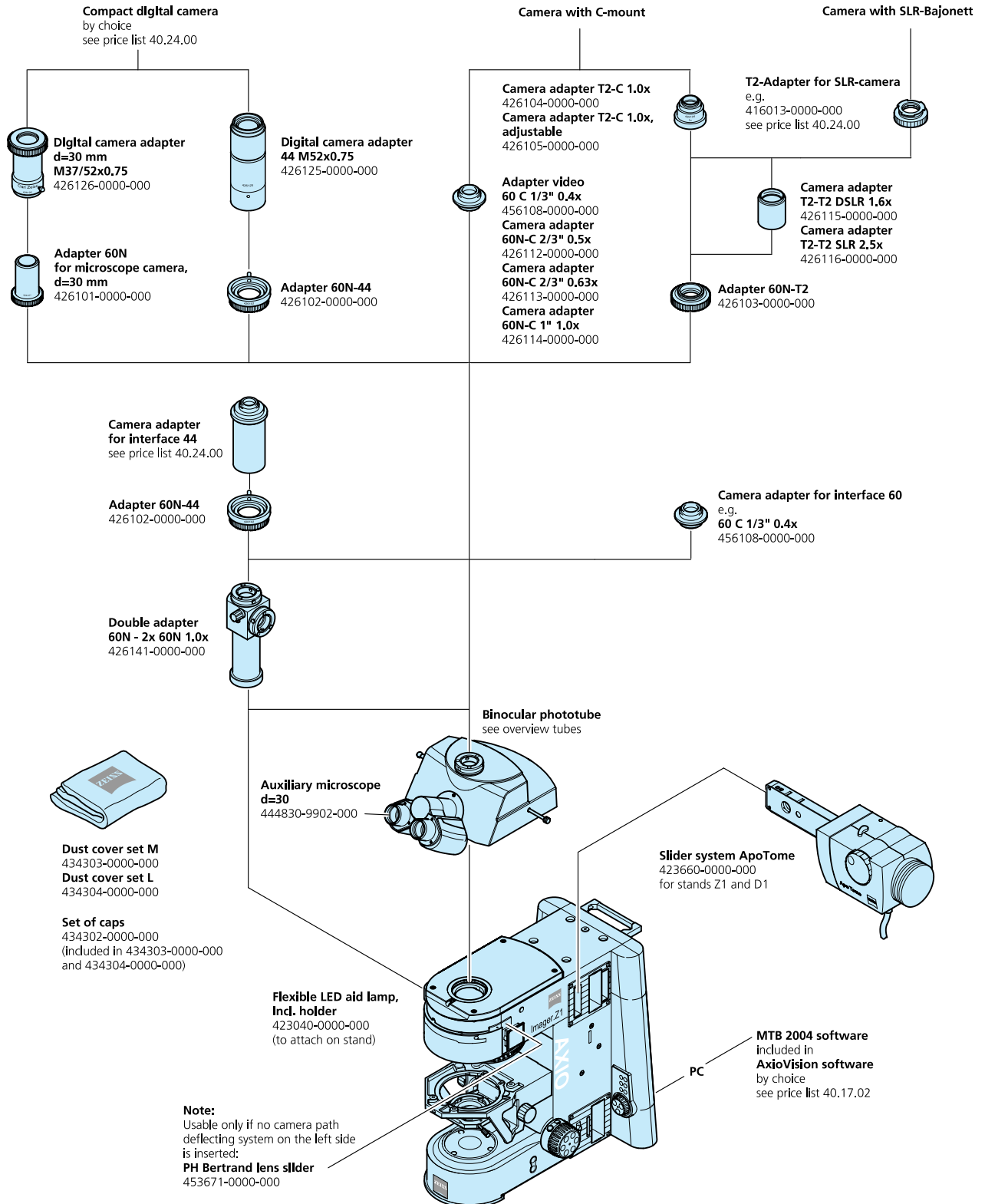

# All Advantages

---

## Optics

- High contrast in all techniques thanks to new IC<sup>2</sup>S beam path
- Unprecedented resolution thanks to new high-performance objectives
- Unique image quality thanks to optimized Differential Interference Contrast
- Brilliant darkfield from 2.5x to 100x combined with brightfield in one condensor

---

## Fluorescence

- Highest image quality because of the apochromatically corrected beampath
- Visibly higher contrast due to active stray light minimization
- Up to 70% higher excitation intensity thanks to high-performance filter sets and optimized reflected light path
- Up to 50% shorter exposure times
- Fast 6x and 10x reflector turrets
- Homogeneous illumination thanks to convenient self-aligning HBO lamp
- LCI Plan-Neofluar objectives for optimum live cell imaging

---

## Intelligence

- Standard interfaces for direct communication internally or externally
- Networkable and remote-controllable
- Automatic component identification
- Lightmanager for fast and easy change between contrast methods

---

## Ergonomics

- Ideal viewing posture thanks to new ergotube
- Efficient and relaxed working over many hours
- Intuitive operation thanks to touch screen
- Everything within easy reach with control buttons directly at the focusing drive

---

## Stand

### Architecture

- Extremely flexible and modularly expandable
- Motorized for maximum level of automation
- Imaging Cell: "stable cell" isolated from stand to prevent vibrations
- Accessible planes in reflected and transmitted light path
- Accessible planes in infinity light path

---

## Imaging

- Rapid image acquisition with outstanding quality in up to 6 dimensions
  - Perfectly harmonized system components
  - Positioning precision: the x/y-scanning stage and motorized z-focus
  - Up to 40% faster experiments
- 

Carl Zeiss  
Light Microscopy

P.O.B 4041  
37030 Göttingen  
Phone: ++49 551 5060 660  
Telefax: ++49 551 5060 464  
E-Mail: [micro@zeiss.de](mailto:micro@zeiss.de)  
[www.zeiss.de/Axiolmager](http://www.zeiss.de/Axiolmager)